

**AMP**  
EU Version

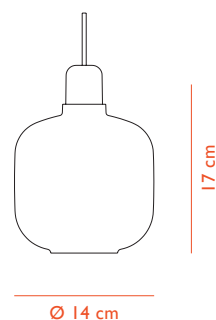

## Amp Pendant Small - EU Version



### DESCRIPTION

Amp is a collection of lamps inspired by old tube amplifiers from the 1960s. The sophisticated range is characterized by its high-quality materials of glass, brass and marble that add a visual fragility and sensuous heaviness. Amp has a nostalgic and at the same time, contemporary feel.

### DESIGN

Simon Legald, 2014

### MATERIAL

Glass / Marble / Brass Plated Steel

### CONSTRUCTION

The Amp collection consists of five lamps, which all follow the simple construction of a glass shade slipped over a marble or brass base. The shape of each part ensures stability and easy handling.

### MAINTENANCE

Clean with damp cloth. Avoid use of all-purpose cleaners and other degreasing detergents.

### CORD

4 m textile cord (gold glass - green cord / smoked glass - black cord / white glass - white cord).

### CANOPY

Included, black or white color, H: 7,7 x Ø: 9 cm 0,04 kg

### DIMMABLE FUNCTION

Yes - with dimmable light source. Ensure the dimmer is suitable for LED.

### VOLTAGE

220-240V

### MAX LOAD

40 W

### FREQUENCY

50/60 Hz

### IP RATING

IP20

### CLASSIFICATION

Class II

### SOCKET

E14

### LIGHT SOURCE - RECOMMENDED

Art. No.: 504050 LED E14 EU, dimmable

Power: 1,5 W

CCT: 2.000 K

Output: 100 lm

Life Span: 15 000 h

CRI: > 90

### GENERAL STANDARD & CERTIFICATES

EN 60598-1:2008+All:2009

EN 60598-2-1: 1989

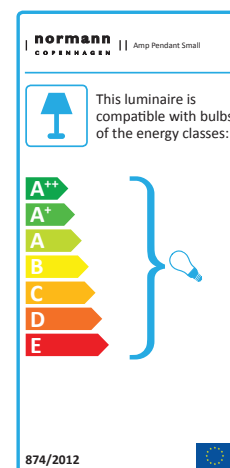

### COLOR



White Glass /  
White Marble



Smoke Glass /  
Black Marble



Gold Glass /  
Green Marble



White Glass /  
Brass



Smoke Glass /  
Brass

# Amp Pendant Large - EU Version

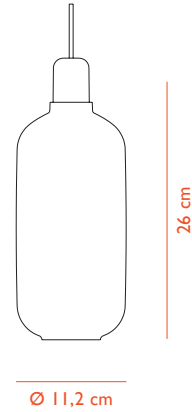

## DESCRIPTION

Amp is a collection of lamps inspired by old tube amplifiers from the 1960s. The sophisticated range is characterized by its high-quality materials of glass, brass and marble that add a visual fragility and sensuous heaviness. Amp has a nostalgic and at the same time, contemporary feel.

## DESIGN

Simon Legald, 2014

## MATERIAL

Glass / Marble / Brass Plated Steel

## CONSTRUCTION

The Amp collection consists of five lamps, which all follow the simple construction of a glass shade slipped over a marble or brass base. The shape of each part ensures stability and easy handling.

## MAINTENANCE

Clean with damp cloth. Avoid use of all-purpose cleaners and other degreasing detergents.

## CORD

4 m textile cord (gold glass - green cord / smoked glass - black cord / white glass - white cord).

## CANOPY

Included, black or white color, H: 7,7 x Ø: 9 cm 0,04 kg

## DIMMABLE FUNCTION

Yes - with dimmable light source. Ensure the dimmer is suitable for LED.

## VOLTAGE

220-240V

## MAX LOAD

40 W

## FREQUENCY

50/60 Hz

## IP RATING

IP20

## CLASSIFICATION

Class II

## SOCKET

E14

## LIGHT SOURCE - RECOMMENDED

Art. No.: 504050 LED E14 EU, dimmable

Power: 1,5 W

CCT: 2000 K

Output: 100 lm

Life Span: 15 000 h

CRI: > 90

## GENERAL STANDARD & CERTIFICATES

EN 60598-1:2008+All:2009

EN 60598-2-1: 1989

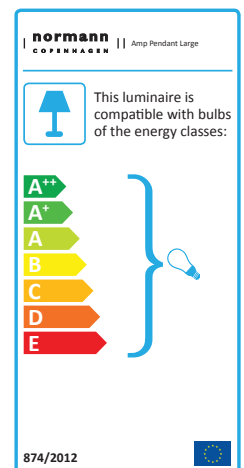

## COLOR



White Glass /  
White Marble



Smoke Glass /  
Black Marble



Gold Glass /  
Green Marble



White Glass /  
Brass



Smoke Glass /  
Brass

## Amp Table Lamp - EU Version

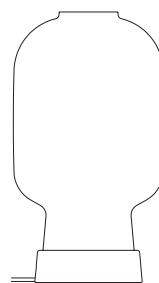

26,5 cm

Ø 14 cm

### DESCRIPTION

Amp is a collection of lamps inspired by old tube amplifiers from the 1960s. The sophisticated range is characterized by its high-quality materials of glass, brass and marble that add a visual fragility and sensuous heaviness. Amp has a nostalgic and at the same time, contemporary feel.

### DESIGN

Simon Legald, 2014

### MATERIAL

Glass / Marble / Brass Plated Steel

### CONSTRUCTION

The Amp collection consists of five lamps, which all follow the simple construction of a glass shade slipped over a marble or brass base. The shape of each part ensures stability and easy handling.

### MAINTENANCE

Clean with damp cloth. Avoid use of all-purpose cleaners and other degreasing detergents.

### CORD

2 m textile cord with switch (gold glass - green cord / smoked glass - black cord / white glass - white cord).

### DIMMABLE FUNCTION

No

### VOLTAGE

220-240 V

### MAX LOAD

40 W

### FREQUENCY

50/60 Hz

### IP RATING

IP20

### CLASSIFICATION

Class II

### SOCKET

E14

### LIGHT SOURCE - RECOMMENDED

Art. No.: 504050 LED E14 EU, dimmable

Power: 1,5 W

CCT: 2000 K

Output: 100 lm

Life Span: 15 000 h

CRI: > 90

### GENERAL STANDARD & CERTIFICATES

EN 60598-1:2008+All:2009

EN 60598-2-4: 1997

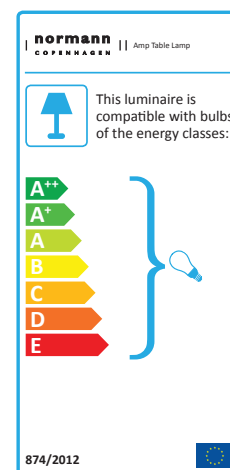

### COLOR



White Glass /  
White Marble



Smoke Glass /  
Black Marble



Gold Glass /  
Green Marble



White Glass /  
Brass



Smoke Glass /  
Brass

## Amp Chandelier Small - EU Version

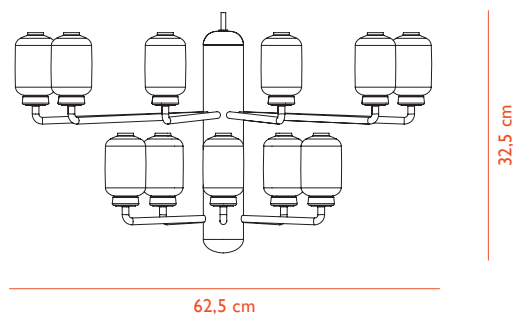
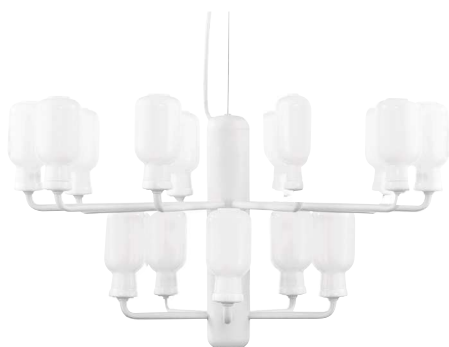

### DESCRIPTION

Amp is a collection of lamps inspired by old tube amplifiers from the 1960s. The sophisticated range is characterized by its high-quality materials of glass, brass and marble that add a visual fragility and sensuous heaviness. Amp has a nostalgic and at the same time, contemporary feel.

### DESIGN

Simon Legald, 2014

### MATERIAL

Glass / Marble / Brass Plated Steel

### CONSTRUCTION

The Amp collection consists of five lamps, which all follow the simple construction of a glass shade slipped over a marble or brass base. The shape of each part ensures stability and easy handling.

### MAINTENANCE

Clean with damp cloth. Avoid use of all-purpose cleaners and other degreasing detergents.

### CORD

4 m textile cord (gold glass - green cord / smoked glass - black cord / white glass - white cord).

### CANOPY

Included, black or white color, H: 7,7 x Ø: 9 cm 0,04 kg

### DIMMABLE FUNCTION

No

### VOLTAGE

220-240V

### MAX LOAD

12 W

### FREQUENCY

50/60 Hz

### IP RATING

IP20

### CLASSIFICATION

Class II

### SOCKET

G4

### LIGHT SOURCE - INCLUDED

LED included: SMD2835, Art. No.: 502069 15x

Power: 0,4 W

CCT: 3 000 K

Output: 40 lm

Life Span: 10 000 h

CRI: ~ 80

### GENERAL STANDARD & CERTIFICATES

EN 60598-2-1: 1989

EN 60598-1: 2015

EN 62031: 2008+A1:2013+A2:2015

EN 62471: 2008

EN 62493: 2015

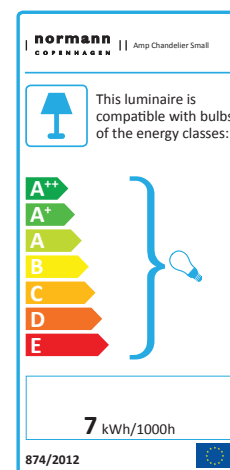

### COLOR



White Glass /  
White Marble



Smoke Glass /  
Black Marble



Gold Glass /  
Green Marble

## Amp Chandelier Large - EU Version

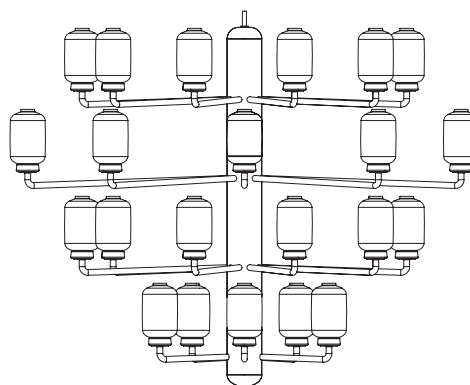

62,5 cm

85 cm

### DESCRIPTION

Amp is a collection of lamps inspired by old tube amplifiers from the 1960s. The sophisticated range is characterized by its high-quality materials of glass, brass and marble that add a visual fragility and sensuous heaviness. Amp has a nostalgic and at the same time, contemporary feel.

### DESIGN

Simon Legald, 2014

### MATERIAL

Glass / Marble / Brass Plated Steel

### CONSTRUCTION

The Amp collection consists of five lamps, which all follow the simple construction of a glass shade slipped over a marble or brass base. The shape of each part ensures stability and easy handling.

### MAINTENANCE

Clean with damp cloth. Avoid use of all-purpose cleaners and other degreasing detergents.

### CORD

4 m textile cord (gold glass - green cord / smoked glass - black cord / white glass - white cord).

### CANOPY

Included, black or white color, H: 7,7 x Ø: 9 cm 0,04 kg

### DIMMABLE FUNCTION

No

### VOLTAGE

220-240V

### MAX LOAD

16 W

### FREQUENCY

50/60 Hz

### IP RATING

IP20

### CLASSIFICATION

Class II

### SOCKET

G4

### LIGHT SOURCE - INCLUDED

LED included: SMD2835, Art. No.: 502069 35x

Power: 0,4 W

CCT: 3 000 K

Output: 40 lm

Life Span: 10 000 h

CRI: ~ 80

### GENERAL STANDARD & CERTIFICATES

EN 55015:2013

EN 61000-3-2:2014

EN 61000-3-3:2013

EN 61547:2009

EN 62493:2010

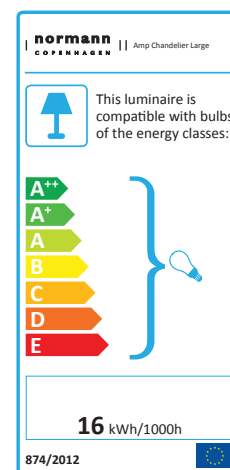

### COLOR



White Glass /  
White Marble



Smoke Glass /  
Black Marble



Gold Glass /  
Green Marble

**AMP**  
US Version



## Amp Pendant Small - US Version

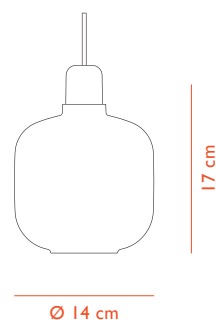

### DESCRIPTION

Amp is a collection of lamps inspired by old tube amplifiers from the 1960s. The sophisticated range is characterized by its high-quality materials of glass, brass and marble that add a visual fragility and sensuous heaviness. Amp has a nostalgic and at the same time, contemporary feel.

### DESIGN

Simon Legald, 2014

### MATERIAL

Glass / Marble / Brass Plated Steel

### CONSTRUCTION

The Amp collection consists of five lamps, which all follow the simple construction of a glass shade slipped over a marble or brass base. The shape of each part ensures stability and easy handling.

### MAINTENANCE

Clean with damp cloth. Avoid use of all-purpose cleaners and other degreasing detergents.

### CORD

4 m textile cord (gold glass - green cord / smoked glass - black cord / white glass - white cord).

### CANOPY

Included, black or white color, H: 7,7 x Ø: 9 cm 0,04 kg

### DIMMABLE FUNCTION

Yes - with dimmable light source. Ensure the dimmer is suitable for LED.

### VOLTAGE

120V

### MAX LOAD

40W

### FREQUENCY

60Hz

### IP RATING

IP20

### CLASSIFICATION

Class I

### SOCKET

E12

### LIGHT SOURCE - RECOMMENDED

Art. No.: 504060 LED E12 US, dimmable

Power: 3,5 W

CCT: 2000K

Output: 100lm

Life Span: 15 000 h

CRI: > 90

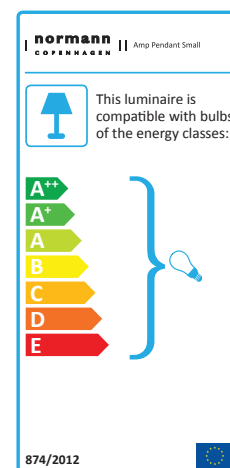

 IP20 



### COLOR



White Glass /  
White Marble



Smoke Glass /  
Black Marble



Gold Glass /  
Green Marble



White Glass /  
Brass



Smoke Glass /  
Brass



## Amp Pendant Large - US Version

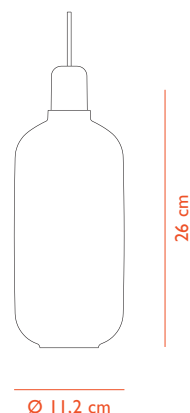

### DESCRIPTION

Amp is a collection of lamps inspired by old tube amplifiers from the 1960s. The sophisticated range is characterized by its high-quality materials of glass, brass and marble that add a visual fragility and sensuous heaviness. Amp has a nostalgic and at the same time, contemporary feel.

### DESIGN

Simon Legald, 2014

### MATERIAL

Glass / Marble / Brass Plated Steel

### CONSTRUCTION

The Amp collection consists of five lamps, which all follow the simple construction of a glass shade slipped over a marble or brass base. The shape of each part ensures stability and easy handling.

### MAINTENANCE

Clean with damp cloth. Avoid use of all-purpose cleaners and other degreasing detergents.

### CORD

4 m textile cord (gold glass - green cord / smoked glass - black cord / white glass - white cord).

### CANOPY

Included, black or white color, H: 7,7 x Ø: 9 cm 0,04 kg

### DIMMABLE FUNCTION

Yes - with dimmable light source. Ensure the dimmer is suitable for LED.

### VOLTAGE

120V

### MAX LOAD

40W

### FREQUENCY

60Hz

### IP RATING

IP20

### CLASSIFICATION

Class I

### SOCKET

E12

### LIGHT SOURCE - RECOMMENDED

Art. No.: 504060 LED E12 US, dimmable

Power: 3,5 W

CCT: 2000K

Output: 100lm

Life Span: 15 000 h

CRI: > 90

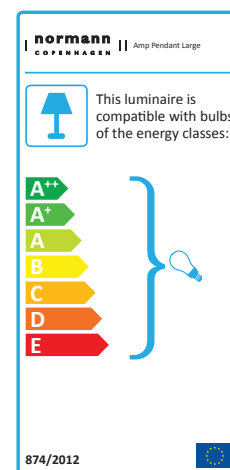

 IP20 



### COLOR



White Glass /  
White Marble



Smoke Glass /  
Black Marble



Gold Glass /  
Green Marble



White Glass /  
Brass



Smoke Glass /  
Brass

## Amp Table Lamp - US Version

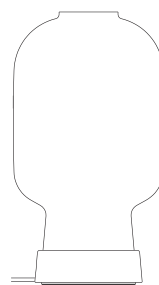

26,5 cm

Ø 14 cm

### DESCRIPTION

Amp is a collection of lamps inspired by old tube amplifiers from the 1960s. The sophisticated range is characterized by its high-quality materials of glass, brass and marble that add a visual fragility and sensuous heaviness. Amp has a nostalgic and at the same time, contemporary feel.

### DESIGN

Simon Legald, 2014

### MATERIAL

Glass / Marble / Brass Plated Steel

### CONSTRUCTION

The Amp collection consists of five lamps, which all follow the simple construction of a glass shade slipped over a marble or brass base. The shape of each part ensures stability and easy handling.

### MAINTENANCE

Clean with damp cloth. Avoid use of all-purpose cleaners and other degreasing detergents.

### CORD

2 m textile cord with switch (gold glass - green cord / smoked glass - black cord / white glass - white cord).

### DIMMABLE FUNCTION

No

### VOLTAGE

120 V

### MAX LOAD

40 W

### FREQUENCY

60 Hz

### IP RATING

IP20

### CLASSIFICATION

Class II

### SOCKET

E12

### LIGHT SOURCE - RECOMMENDED

Art. No.: 504060 LED E12 US, dimmable

Power: 3,5 W

CCT: 2000 K

Output: 100 lm

Life Span: 15 000 h

CRI: > 90

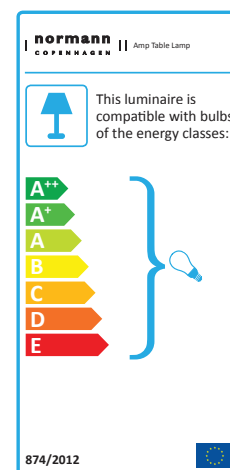

### COLOR



White Glass /  
White Marble



Smoke Glass /  
Black Marble



Gold Glass /  
Green Marble



White Glass /  
Brass



Smoke Glass /  
Brass

## Amp Chandelier Small - US Version

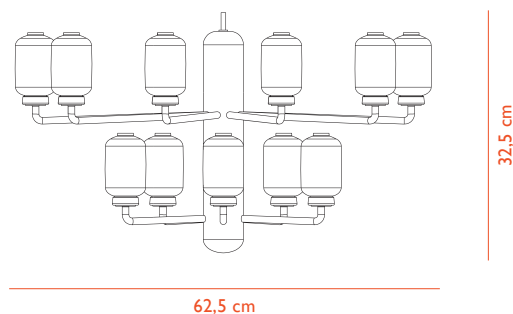
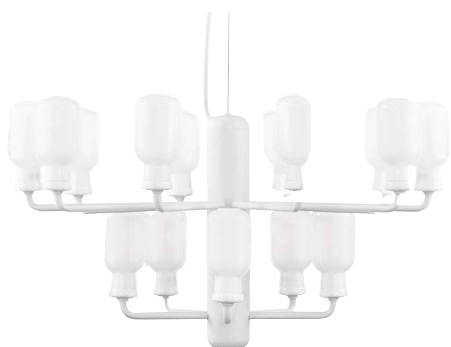

### DESCRIPTION

Amp is a collection of lamps inspired by old tube amplifiers from the 1960s. The sophisticated range is characterized by its high-quality materials of glass, brass and marble that add a visual fragility and sensuous heaviness. Amp has a nostalgic and at the same time, contemporary feel.

### DESIGN

Simon Legald, 2014

### MATERIAL

Glass / Marble / Brass Plated Steel

### CONSTRUCTION

The Amp collection consists of five lamps, which all follow the simple construction of a glass shade slipped over a marble or brass base. The shape of each part ensures stability and easy handling.

### MAINTENANCE

Clean with damp cloth. Avoid use of all-purpose cleaners and other degreasing detergents.

### CORD

4 m textile cord (gold glass - green cord / smoked glass - black cord / white glass - white cord).

### CANOPY

Included, black or white color, H: 7,7 x Ø: 9 cm 0,04 kg

### DIMMABLE FUNCTION

No

### VOLTAGE

120 V

### MAX LOAD

12 W

### FREQUENCY

60 Hz

### IP RATING

IP20

### CLASSIFICATION

Class I

### SOCKET

G4

### LIGHT SOURCE - INCLUDED

LED included: SMD2835, Art. No.: 502069 15x

Power: 0,4 W

CCT: 3 000 K

Output: 40 lm

Life Span: 10 000 h

CRI: ~ 80

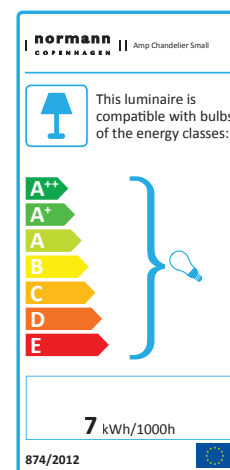

UL IP20



### COLOR



White Glass /  
White Marble



Smoke Glass /  
Black Marble



Gold Glass /  
Green Marble

## Amp Chandelier Large - US Version

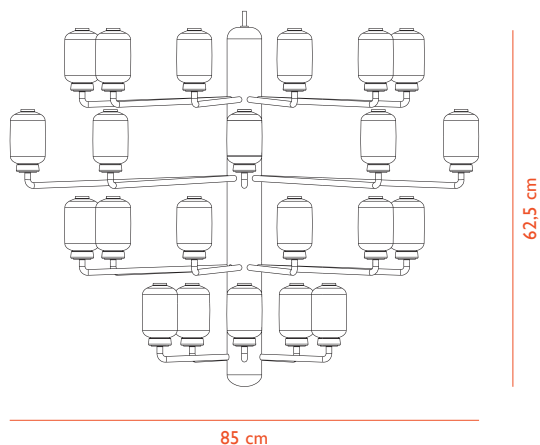

### DESCRIPTION

Amp is a collection of lamps inspired by old tube amplifiers from the 1960s. The sophisticated range is characterized by its high-quality materials of glass, brass and marble that add a visual fragility and sensuous heaviness. Amp has a nostalgic and at the same time, contemporary feel.

### DESIGN

Simon Legald, 2014

### MATERIAL

Glass / Marble / Brass Plated Steel

### CONSTRUCTION

The Amp collection consists of five lamps, which all follow the simple construction of a glass shade slipped over a marble or brass base. The shape of each part ensures stability and easy handling.

### MAINTENANCE

Clean with damp cloth. Avoid use of all-purpose cleaners and other degreasing detergents.

### CORD

4 m textile cord (gold glass - green cord / smoked glass - black cord / white glass - white cord).

### CANOPY

Included, black or white color, H: 7,7 x Ø: 9 cm 0,04 kg

### DIMMABLE FUNCTION

No

### VOLTAGE

120 V

### MAX LOAD

16 W

### FREQUENCY

60 Hz

### IP RATING

IP20

### CLASSIFICATION

Class I

### SOCKET

G4

### LIGHT SOURCE - INCLUDED

LED included: SMD2835, Art. No.: 502069 35x

Power: 0,4 W

CCT: 3 000 K

Output: 40 lm

Life Span: 10 000 h

CRI: ~ 80

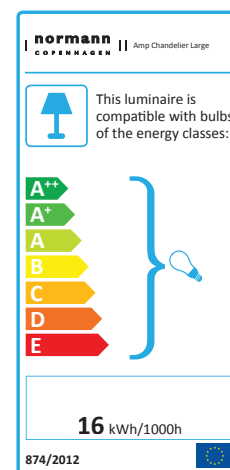

IP20



### COLOR



White Glass /  
White Marble



Smoke Glass /  
Black Marble



Gold Glass /  
Green Marble