

# mdf italia



© COPYRIGHT 2019 MDF ITALIA SRL SOCIETA' UNIPERSONALE

2013 - 2019

## MINIMA 3.0

Designed by Bruno Fattorini

Minima 3.0 by Metrica - design Bruno Fattorini.

Minima 3.0: three stands for the three key elements that compose the system: shelf, frame, cabinets. Essential and flexible, Minima 3.0 represents the natural makeover of Minima, MDF Italia collection's icon product, special mention at the XVII Compasso D'Oro ADI in 1998. Technology and innovation have enabled this thin aluminium structure, to propose an increasingly minimal yet strong identity. The storage units (with door, flap opening door, drawers, or open) are simply resting inside the structure and are repositionable quite easily. Uprights and shelves made of matt lacquered white and graphite grey extruded aluminium (100% recyclable). Nominal lengths of cabinets: 30, 60, 90 cm, available in a matt lacquered micro-goffered finish or in a wood variant. Two options: ground-resting (in 8 heights) or hanging (in 4 heights), always with a 33 cm depth.

NOVELTIES 2019

Today Minima 3.0 evolves and renews, turning into a more versatile and adaptable furnishing system, capable of joining more functions.

The new Minima 3.0 is divided into 5 types: GROUND-RESTING, HANGING, SKETCH, SIDEBOARD AND ROOM DIVIDER. In addition, for the ground-resting version, two new heights are available - 261.5 e 298 - and new shelves with LED lights integration.

[Find out more about the sketch, sideboard and Room Divider versions.](#)

[WATCH THE VIDEO INTERVIEW WITH THE DESIGNERS](#)

## STRUCTURE

Uprights and shelves made of extruded aluminium and assembled together by using a concealed joining system, capable of giving the structure stability and a special resistance to loads.

Minima 3.0 is entirely made of 100% recyclable aluminium.

### MINIMA GROUND-RESTING

The wall fixing is for always suggested for heights 152 / 188.5 / 225 / 261,5 / 298 cm. The wall end frames are provided with holes for the wall fixing.

To use the system H152, H188.5, H225 (except H261,5 and H298) as a room divider for home and work environments, it is mandatory to join two structures together so as to obtain a ground depth of 66 cm to ensure a proper stability to the system.

## CABINETS

The cabinets can be with open, door, flap opening doors or drawers. They are simply resting inside the structure and are repositionable quite easily, thus allowing to meet any storage requirements as desired and to choose your own lifestyle by using different colours, woods and shapes.

# MINIMA 3.0 CABINETS

## CABINETS D33 FOR MINIMA 3.0 GROUND-RESTING, HANGING, SKETCH AND ROOM DIVIDER

### Open cabinet L30



L30 D33 H35 cm

### Cabinet with one or two drawers L60/90



L60 D33 H35 cm

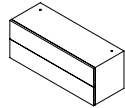

L90 D33 H35 cm



L60 D33 H15 cm  
only Sketch compositions

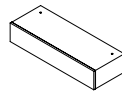

L90 D33 H15 cm  
only Sketch compositions

### Cabinet with door or with flap opening door L60/90



L60 P33 H35 cm

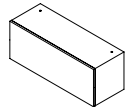

L90 P33 H35 cm

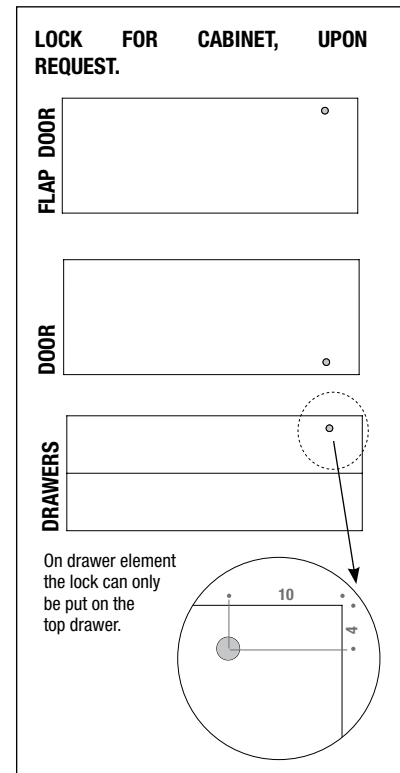

## CABINETS D39 FOR MINIMA 3.0 SIDEBOARD

### With flap opening door or drawers L90/120

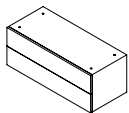

L90 D39 H35 cm

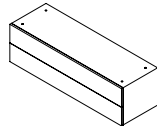

L120 D39 H35 cm

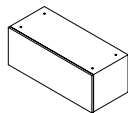

L90 D39 H35 cm

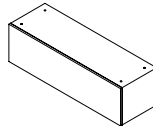

L120 D39 H35 cm

## SHELVES

The shelving lengths are nominal and correspond to the inner usable space of the bookcase

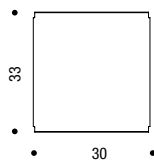

nominal size L30 cm  
real size L31,5 cm

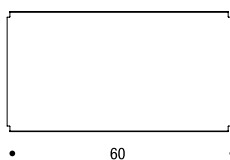

nominal size L60 cm  
real size L61,5 cm

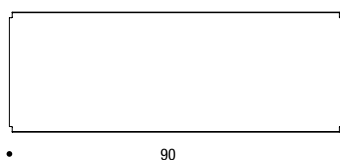

nominal size L90 cm  
real size L91,5 cm



nominal size L120 cm  
real size L121,5 cm

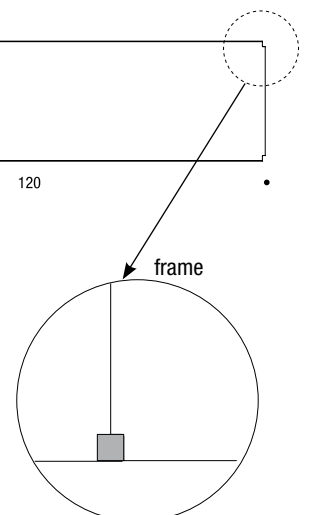

Shelf D30 for Minima 3.0 ground-resting only, NOT available with LED

NB: shelves for Sideboard composition have depth 39 cm

# MINIMA 3.0 GROUND-RESTING

---



**MINIMA 3.0 GROUND-RESTING**

---

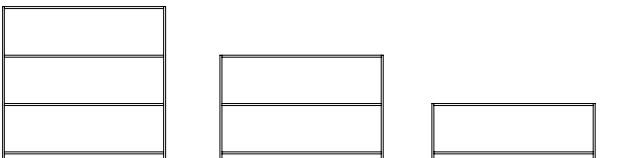
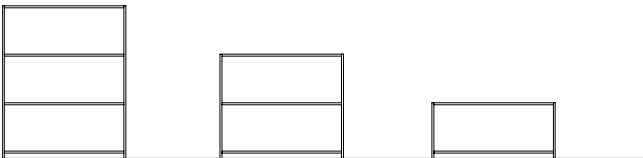
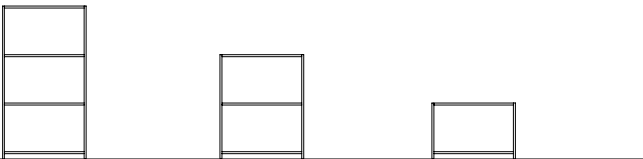
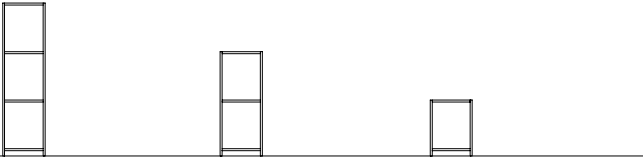

H115.5

H79

H42.5

# MINIMA 3.0 GROUND-RESTING

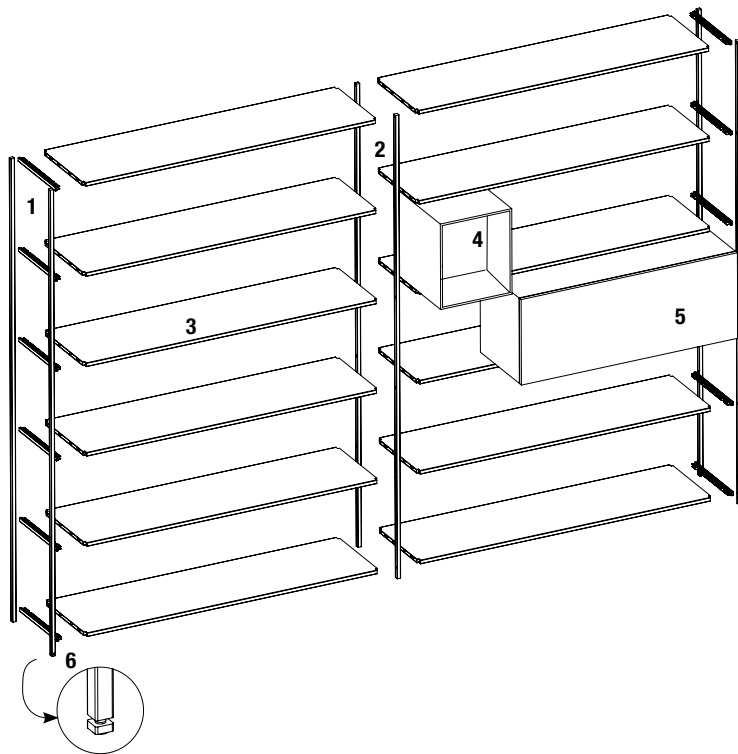

- 1 ground-resting end frame, completed with fittings
- 2 ground-resting intermediate frame
- 3 shelf
- 4 open cabinet, L30
- 5 cabinet
- 6 adjustable feet

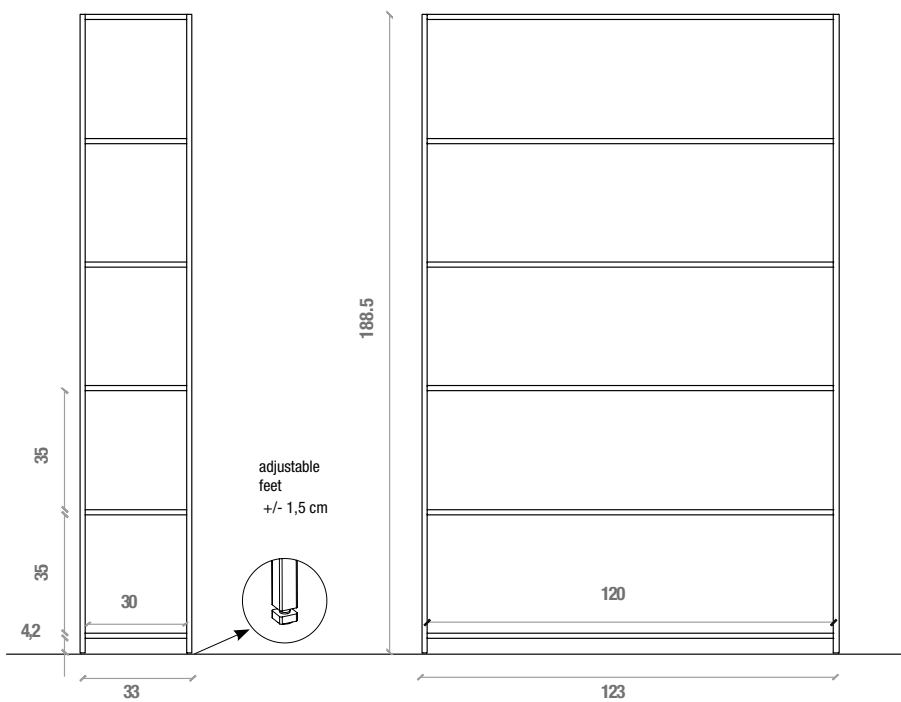

# MINIMA 3.0 GROUND-RESTING

## RULES FOR COMPOSITIONS WITH INTEGRATED LED

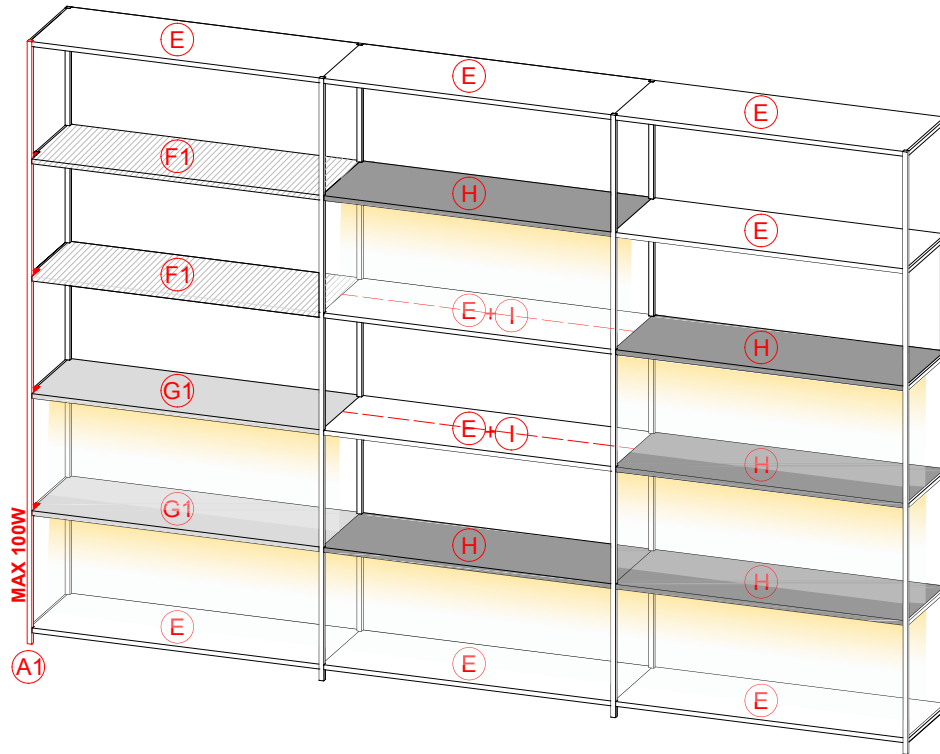

## POWER FOR LED COMPOSITIONS

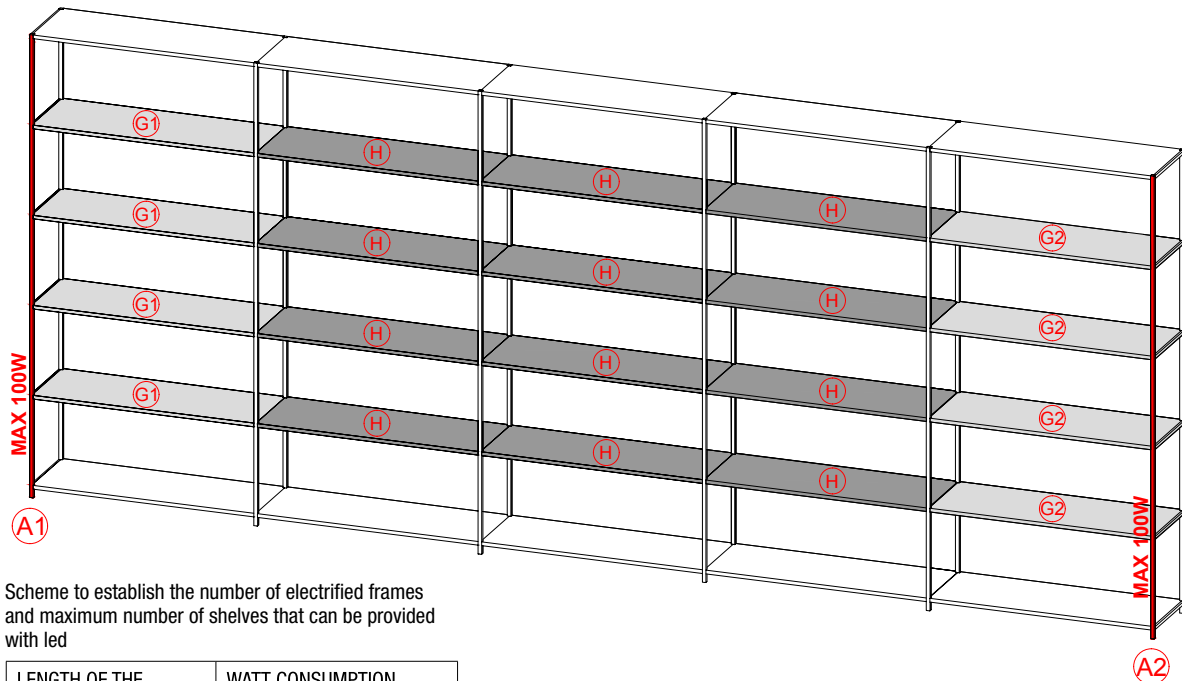

Scheme to establish the number of electrified frames and maximum number of shelves that can be provided with led

LENGTH OF THE SHELF WITH LED	WATT CONSUMPTION FOR EACH SHELF
60 cm	6,5 W
90 cm	10 W
120 cm	13,5 W

### ELECTRIFIED FRAMES FOR ALL HEIGHTS 100W

IN THE ABOVE EXAMPLE: 20 SHELVES WITH LED CM 90 = 20 X 10 W = 200 W\*

\*maximum power limit for 2 electrified frames

# MINIMA 3.0 GROUND-RESTING

## SHELVES



**E** - STANDARD shelf



**F1** - LEFT end shelf with CONNECTOR



**F2** - RIGHT end shelf with CONNECTOR

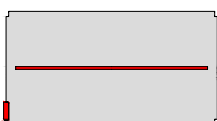

**G1** - LEFT end shelf with CONNECTOR AND LIGHT

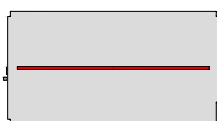

**G2** - RIGHT end shelf with CONNECTOR AND LIGHT

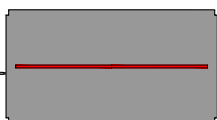

**H** - end/intermediate shelf with LIGHT

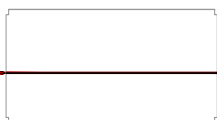

**I** - EXTENSION KIT

## FRAMES

**A1** - electrified frame left - max power 100 W

**A2** - electrified frame right - max power 100 W

Important:

- the electrified frame is always in front
- max 2 electrified frames per composition
- the second electrified frame is needed only if the power exceeds the maximum allowed (100 W per frame)
- max height of the frame 298 cm

## D33 SHELVES

**E** - standard shelf

**F1** - left end shelf with connector

**F2** - right end shelf with connector

**G1** - left end shelf with connector and light

**G2** - right end shelf with connector and light

**H** - end/intermediate shelf with light

**I** - extension kit (to be inserted by the customer)

## ELECTRIC SCHEME OF LEDS

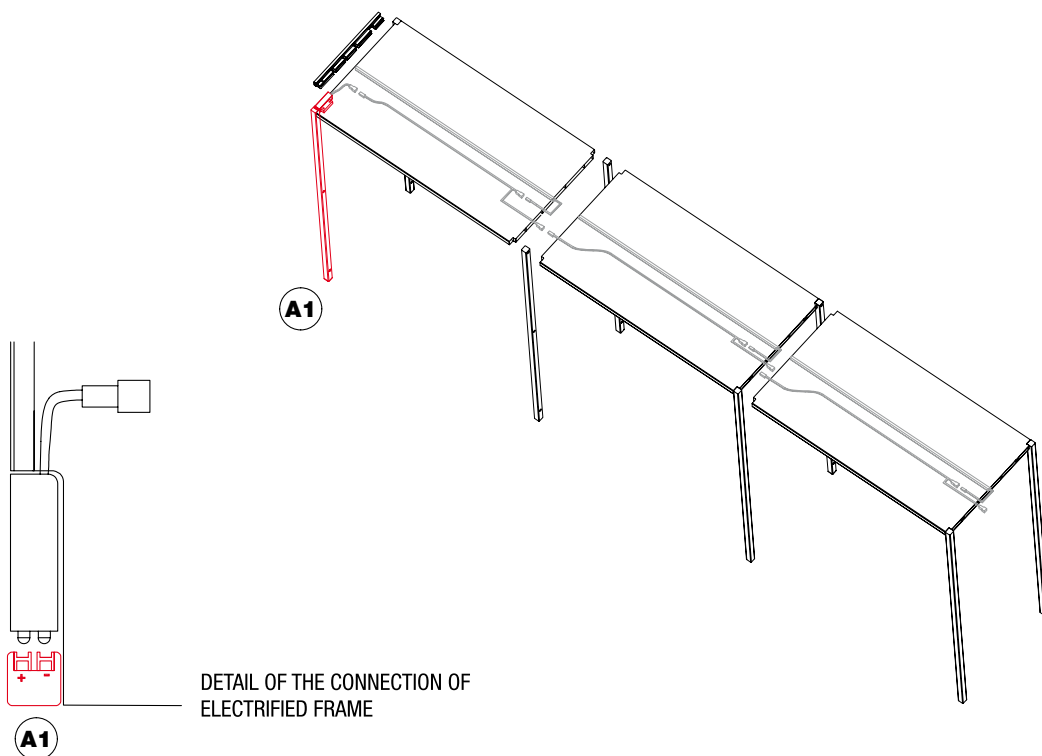



# MINIMA 3.0 HANGING

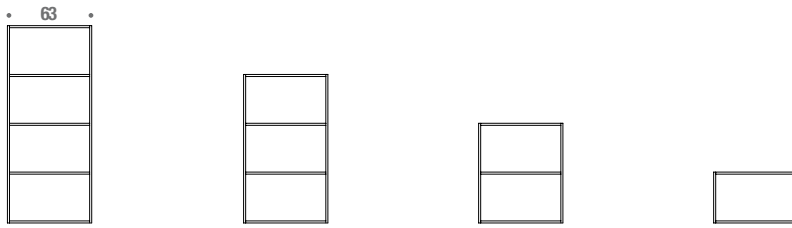

L60

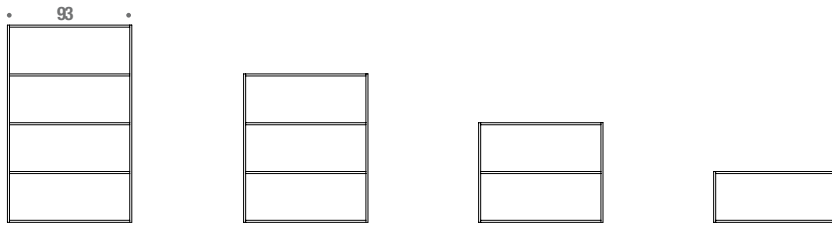

L90

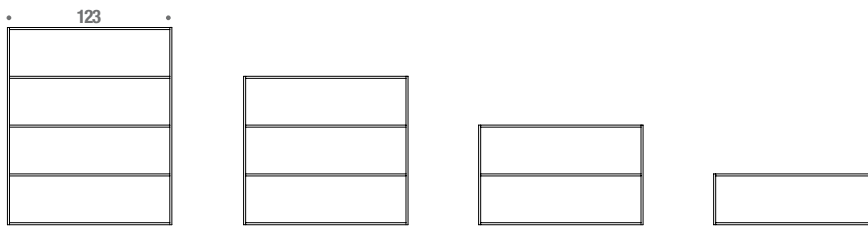

L120

H147.5

H111

H74.5

H38

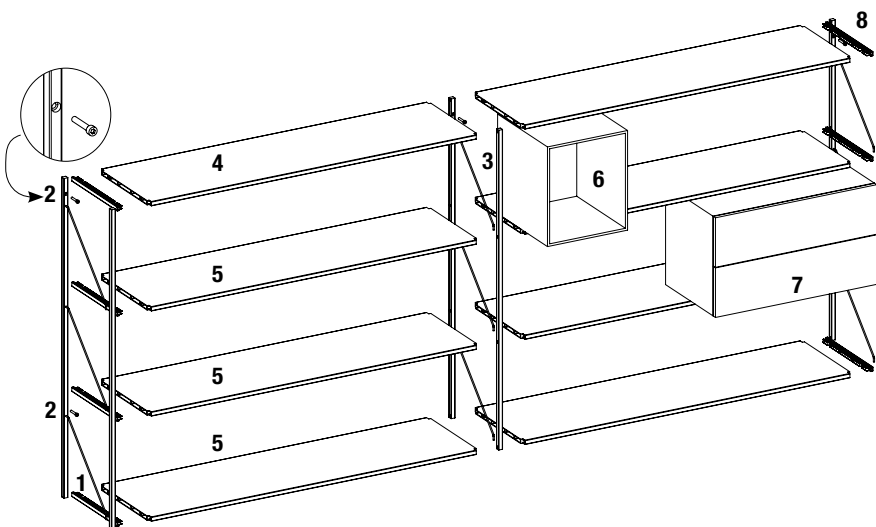

- 1** hanging end frame (L), completed with fittings and tie rods
- 2** wall-fixing
- 3** hanging intermediate frame with tie rods
- 4** top shelf
- 5** shelves (base and intermediate)
- 6** open cabinet, L30
- 7** two-drawer cabinet
- 8** hanging end frame (R), completed with fittings and tie rods

# MINIMA 3.0 SKETCH

---

## SKETCH WITH MATERIAL TOP SHELF

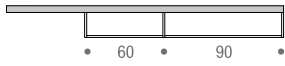

**composition MS-1** L210 D33 H23 cm

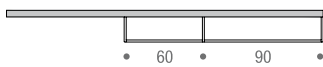

**composition MS-2** L240 D33 H23 cm

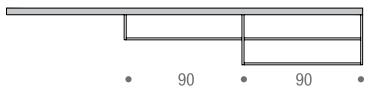

**composition MS-3** L270 D33 H41.5 cm

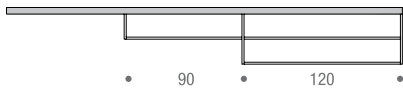

**composition MS-4** L300 D33 H41.5 cm

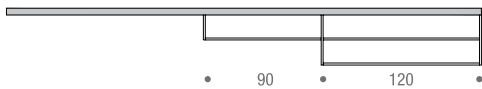

**composition MS-5** L360 D33 H41.5 cm

## SKETCH WITHOUT MATERIAL TOP SHELF

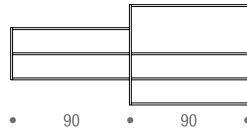

**composition S-1** L185 D33 H74.5 cm

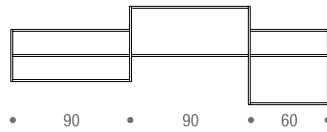

**composition S-2** L246 D33 H74.5 cm

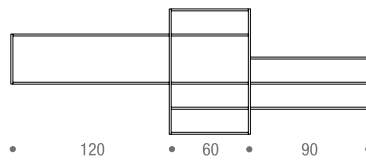

**composition S-3** L276 D33 H93 cm

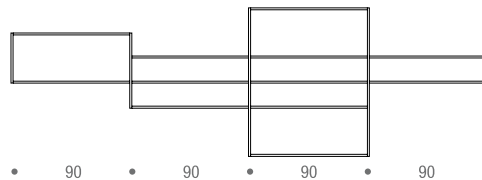

**composition S-4** L368 D33 H110 cm

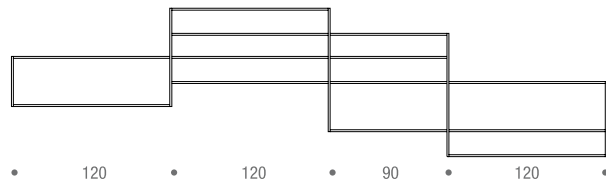

**composition S-5** L458 D33 H110 cm

# MINIMA 3.0 SIDEBORD

---

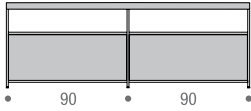

**composition SB-1** L184 D39 H64 cm  
2 cabinets L90 to be added (mandatory)

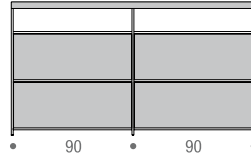

**composition SB-1** L184 D39 H100 cm  
4 cabinets L90 to be added (mandatory)

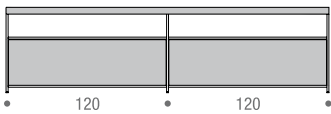

**composition SB-2** L244 D39 H64 cm  
2 cabinets L120 to be added (mandatory)

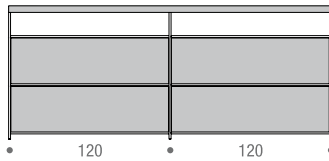

**composition SB-2** L244 D39 H100 cm  
4 cabinets L120 to be added (mandatory)

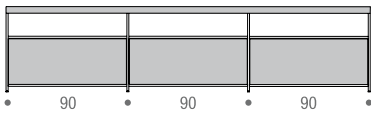

**composition SB-3** L276 D39 H64 cm  
3 cabinets L90 to be added (mandatory)

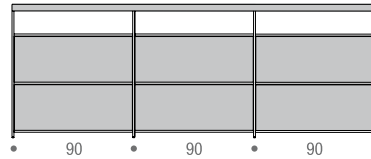

**composition SB-3** L276 D39 H100 cm  
6 cabinets L90 to be added (mandatory)

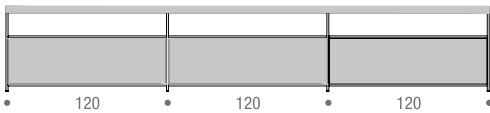

**composition SB-4** L366 D39 H64 cm  
3 cabinets L120 to be added (mandatory)

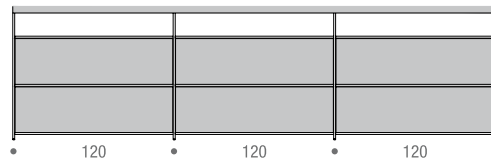

**composition SB-4** L366 D39 H100 cm  
6 cabinets L120 to be added (mandatory)

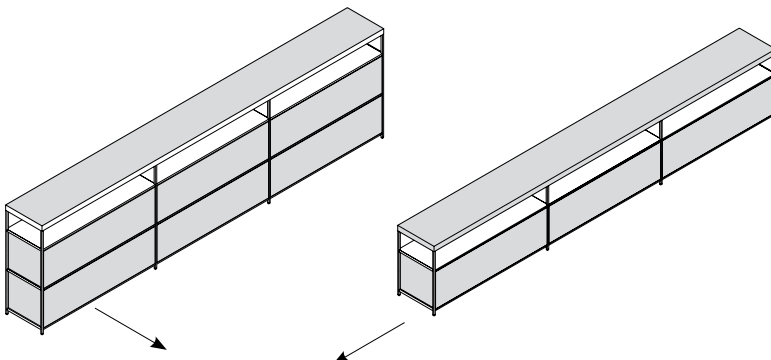

**CABINETS D39 FOR MINIMA 3.0 SIDEBORD WITH FLAP OPENING DOOR OR DRAWERS L90/120 MANDATORY TO BE ADDED**

# MINIMA 3.0 ROOM DIVIDER

## EXAMPLE OF CONFIGURATION WITH 7 SHELVES

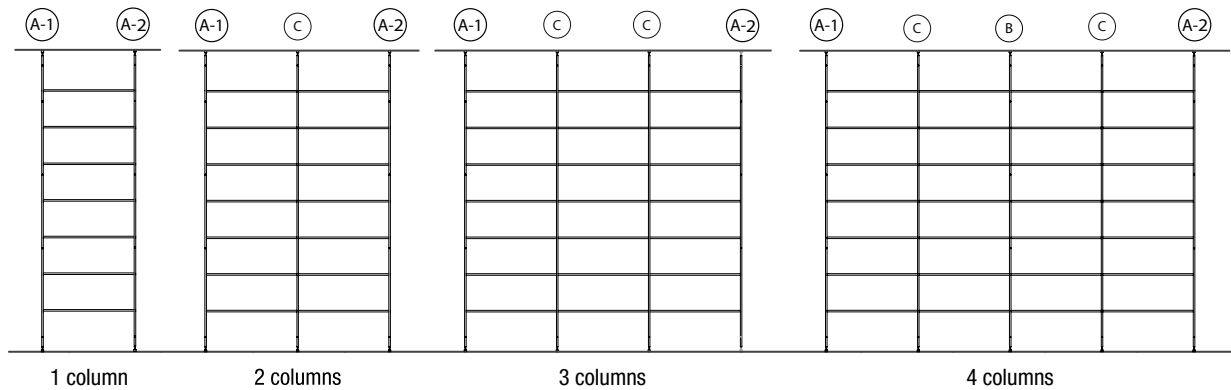

### Width of the compositions and pairing of the shelves

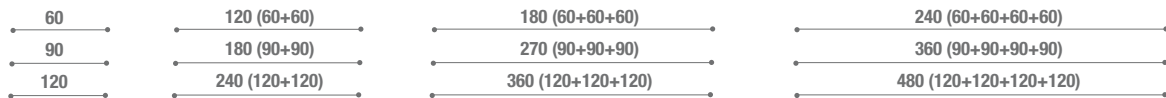

**IMPORTANT:** Compositions max 6 columns. Mixed compositions, eg: 60 + 90 + 60, are not allowed

### LIST OF COMPONENTS OF THE END FRAME

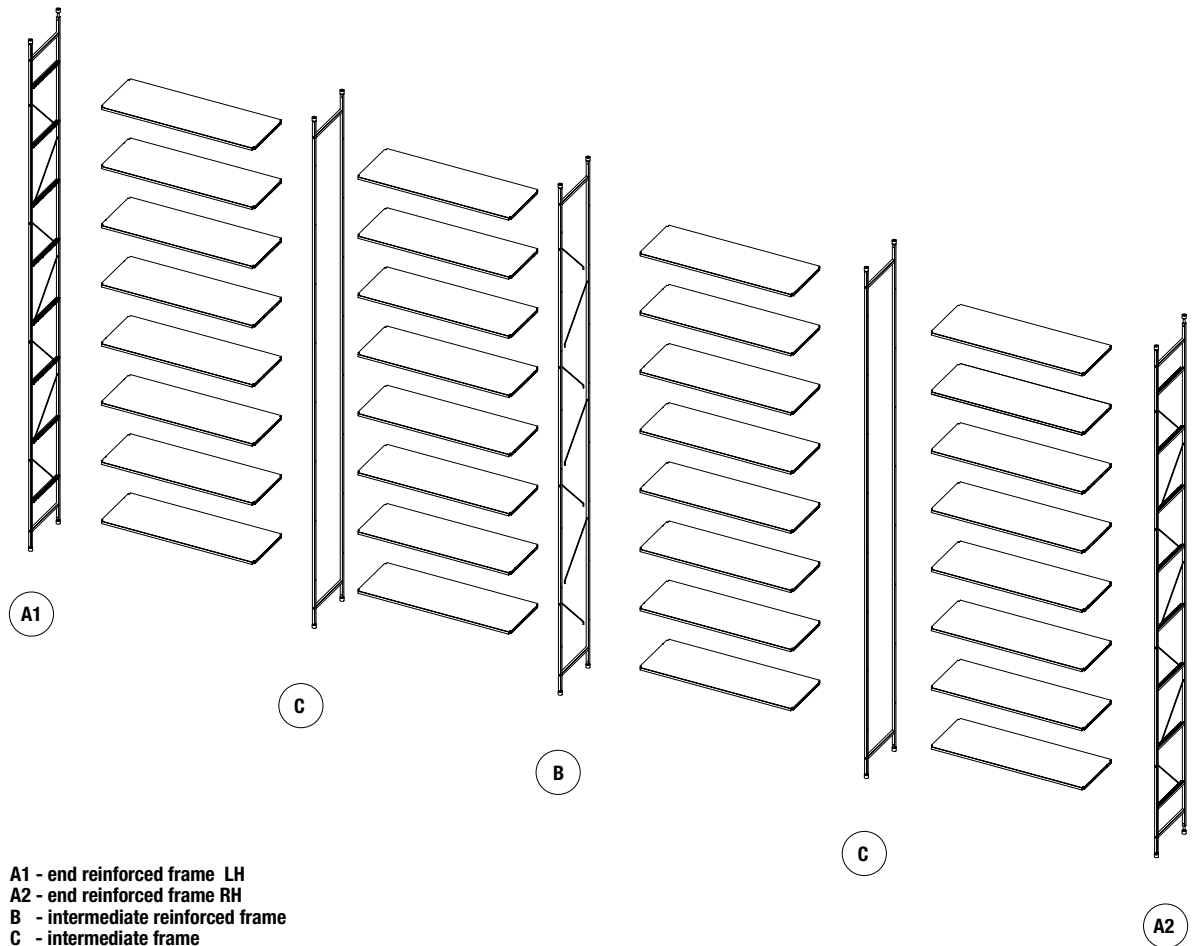

# MINIMA 3.0 ROOM DIVIDER

## EXAMPLE OF CONFIGURATION WITH 7 SHELVES

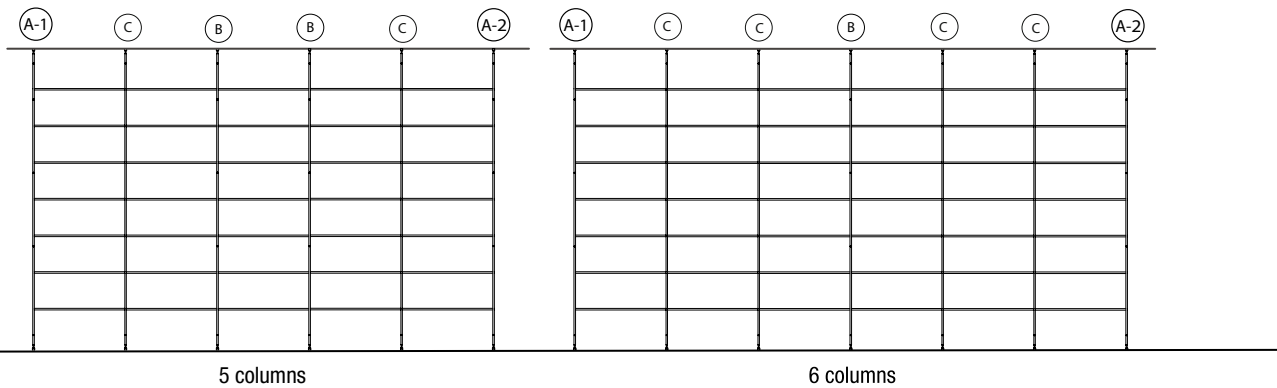

### Width of the compositions and pairing of the shelves



**IMPORTANT: Compositions max 6 columns. Mixed compositions, eg: 60 + 90 + 60, are not allowed**

No. columns	height	A1	A2	B	C	shelf D33	hanging shelf D33	end shelf L D33	end shelf R D33
		reinforced end frame L	reinforced end frame R	reinforced intermediate frame	intermediate frame				
1 column	H250	1	1	-	-	1	5	-	-
	H260	1	1	-	-	1	5	-	-
	H270	1	1	-	-	1	6	-	-
	H280	1	1	-	-	1	6	-	-
	H290	1	1	-	-	1	6	-	-
	H300	1	1	-	-	1	6	-	-
2 columns	H250	1	1	-	1	2	-	5	5
	H260	1	1	-	1	2	-	5	5
	H270	1	1	-	1	2	-	6	6
	H280	1	1	-	1	2	-	6	6
	H290	1	1	-	1	2	-	6	6
	H300	1	1	-	1	2	-	6	6
3 columns	H250	1	1	-	2	8	-	5	5
	H260	1	1	-	2	8	-	5	5
	H270	1	1	-	2	9	-	6	6
	H280	1	1	-	2	9	-	6	6
	H290	1	1	-	2	9	-	6	6
	H300	1	1	-	2	9	-	6	6
4 columns	H250	1	1	1	2	4	-	10	10
	H260	1	1	1	2	4	-	10	10
	H270	1	1	1	2	4	-	12	12
	H280	1	1	1	2	4	-	12	12
	H290	1	1	1	2	4	-	12	12
	H300	1	1	1	2	4	-	12	12
5 campate	H250	1	1	2	2	5	5	10	10
	H260	1	1	2	2	5	5	10	10
	H270	1	1	2	2	5	6	12	12
	H280	1	1	2	2	5	6	12	12
	H290	1	1	2	2	5	6	12	12
	H300	1	1	2	2	5	6	12	12
6 campate	H250	1	1	1	4	16	-	10	10
	H260	1	1	1	4	16	-	10	10
	H270	1	1	1	4	18	-	12	12
	H280	1	1	1	4	18	-	12	12
	H290	1	1	1	4	18	-	12	12
	H300	1	1	1	4	18	-	12	12

# MINIMA 3.0 ROOM DIVIDER

## HEIGHTS

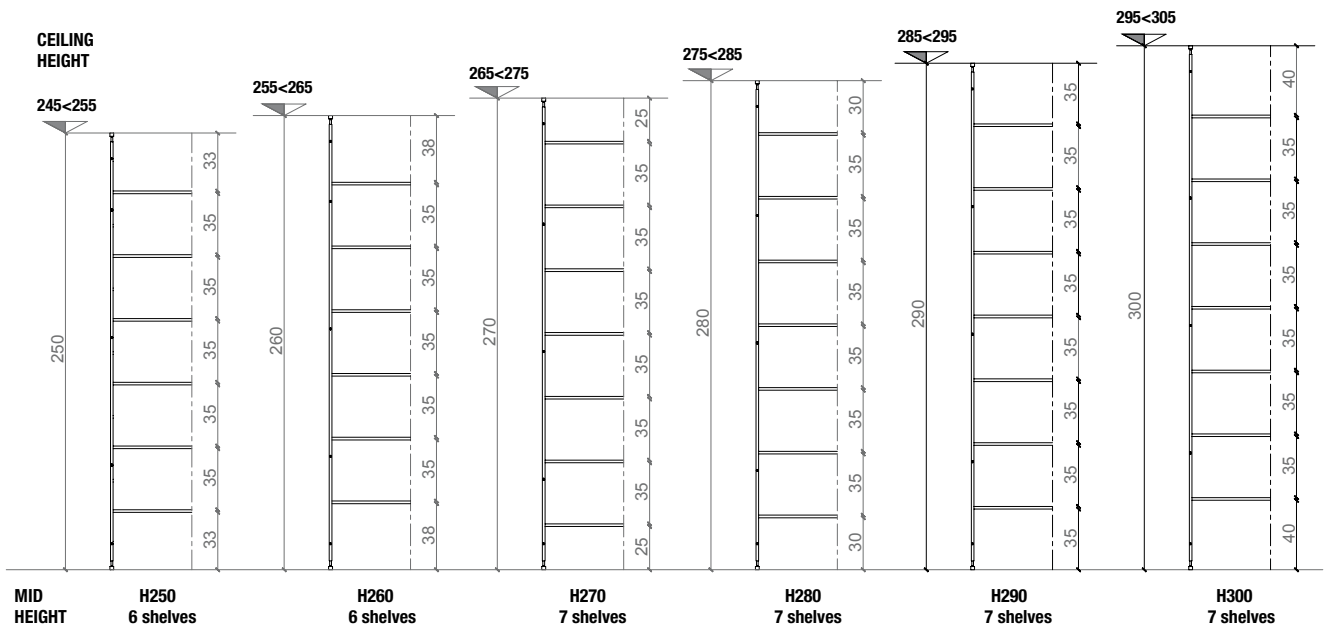

### MINIMUM ADJUSTMENT

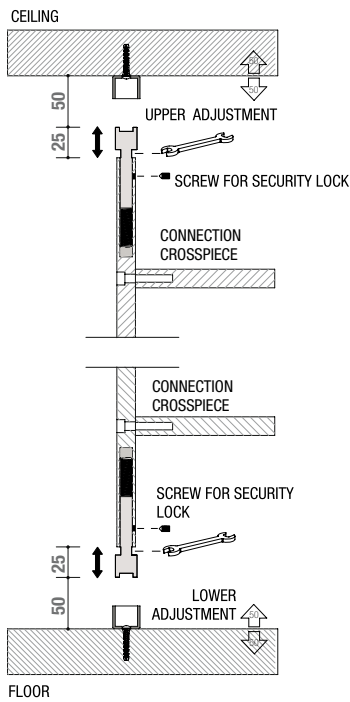

### MAXIMUM ADJUSTMENT

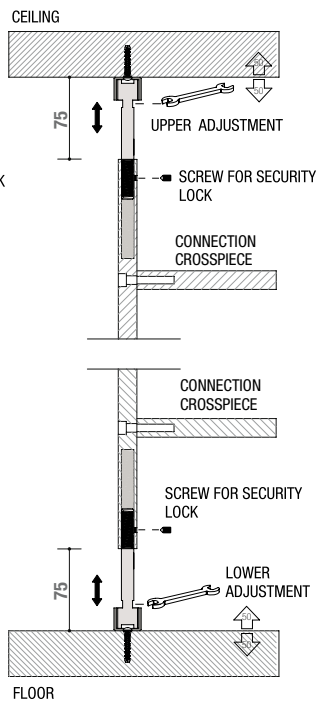

# MINIMA 3.0 ROOM DIVIDER

HEIGHTS ON REQUEST

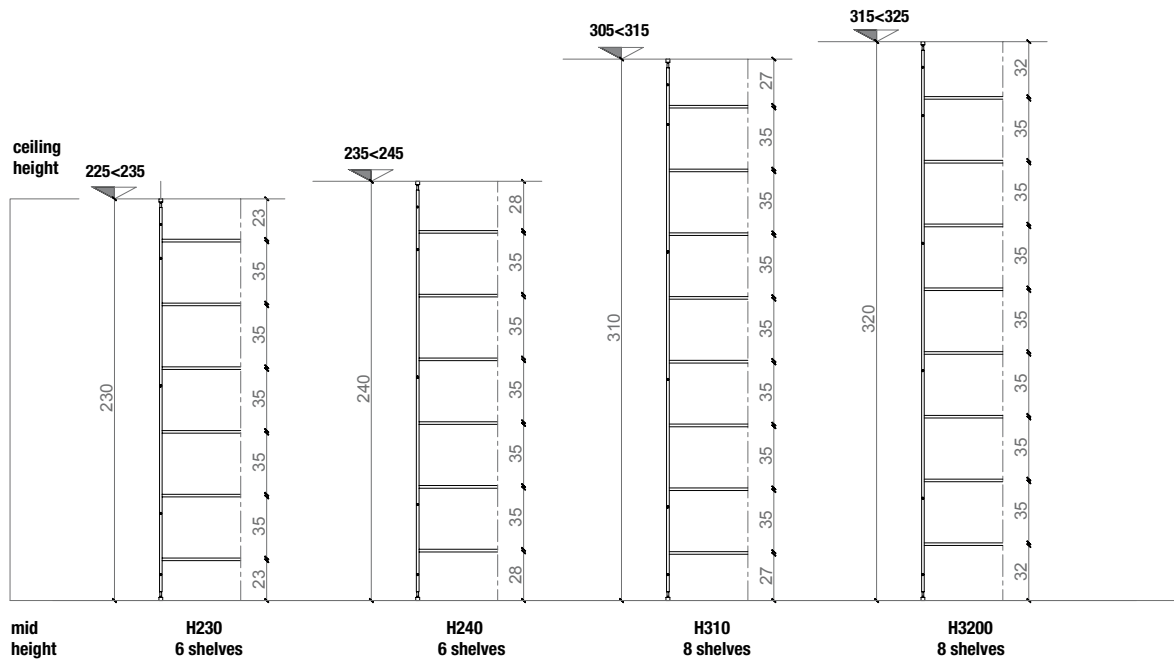

## ELEMENTS NEEDED FOR CUSTOM HEIGHTS

No. columns	height	A1	A2	B	C	shelf D33	hanging shelf D33	end shelf L D33	end shelf R D33
		reinforced end frame L	reinforced end frame R	reinforced intermediate frame	intermediate frame				
1 column	H230	1	1	-	-	1	5	-	-
	H240	1	1	-	-	1	5	-	-
	H310	1	1	-	-	1	7	-	-
	H320	1	1	-	-	1	7	-	-
2 columns	H230	1	1	-	1	2	-	5	5
	H240	1	1	-	1	2	-	5	5
	H310	1	1	-	1	2	-	7	7
	H320	1	1	-	1	2	-	7	7
3 columns	H230	1	1	-	2	8	-	5	5
	H240	1	1	-	2	8	-	5	5
	H310	1	1	-	2	10	-	7	7
	H320	1	1	-	2	10	-	7	7
4 columns	H230	1	1	1	2	4	-	10	10
	H240	1	1	1	2	4	-	10	10
	H310	1	1	1	2	4	-	14	14
	H320	1	1	1	2	4	-	14	14
5 columns	H230	1	1	2	2	5	5	10	10
	H240	1	1	2	2	5	5	10	10
	H310	1	1	2	2	5	7	14	14
	H320	1	1	2	2	5	7	14	14
6 columns	H230	1	1	1	4	16	-	10	10
	H240	1	1	1	4	16	-	10	10
	H310	1	1	1	4	20	-	14	14
	H320	1	1	1	4	20	-	14	14

NB: feasibility, prices and delivery times are to be verified with our Sales Department

# Finishing

The number in the dot corresponds to the number of colour/material finish.

Here below, in the section FINISH OPTIONS, please note all the colours of the materials used for this product.

## SYSTEM

---

### Structure

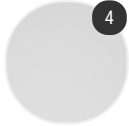

Matt painted



Material top

---

### Cabinet



Door, flap door and drawers

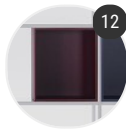

Open units



# Finish options

## STRUCTURE

---

### Matt painted

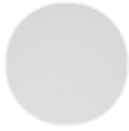

Matt painted  
white X053



Matt painted  
graphite grey  
X054



Matt painted  
shadow grey  
X122



Matt painted  
nickel pearl  
X123

### Material top



Reconstructed  
marble black  
ebony X111



Reconstructed  
marble white  
Carrara X120

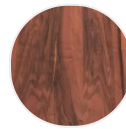

Italian walnut  
(fine wood)  
X119

## CABINET

---

### Door, flap door and drawers



Matt  
lacquered  
white X042



Matt  
lacquered  
shadow grey



Matt  
lacquered  
pearl nickel



Natural black  
wood X029

## Open units



Fine wood,  
Italian walnut  
X119



Natural wood  
X027



Natural grey  
wood X028



Natural black  
wood X029



Matt  
lacquered  
white X042



Matt  
lacquered  
shadow grey



Matt  
lacquered  
nickel pearl

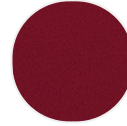

Matt  
lacquered  
dark red X046



Matt  
lacquered  
orange X047

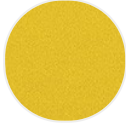

Matt  
lacquered  
mustard  
yellow X048



Matt  
lacquered  
avio blue  
X050



Matt  
lacquered  
green X049