

GRANT

EU Version



normann
COPENHAGEN

Grant Pendant Ø23 cm - EU Version

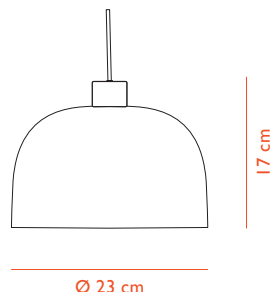

DESCRIPTION

The Grant pendant lamps in two sizes provide ample opportunity for lighting up spaces of various size and character. Due to the dispersion lens, the pendants can be hung high without blinding. An aesthetic and space-optimizing lighting solution, the Grant wall lamps have arms that move from right to left and lampshades that can be tipped up and down, allowing the lamps to take up several different positions.

DESIGN

Simon Legald, 2018

MATERIAL

Brass Plated Steel / Black Plated Steel / Granite

CONSTRUCTION

The six versions of Grant collection are constructed with a replaceable low-energy LED light source with dispersion lens, which is attached with small brass finger screws. The wall lamp versions can move from side to side (ca. 180 degrees). A ball joint connection on the table and floor lamp allows the lampshades to be positioned in diverse directions.

MAINTENANCE

Clean with damp cloth. Avoid use of all-purpose cleaners and other degreasing detergents.

CORD

4 m textile cord, black color.

CANOPY

Included, black color, H: 7,7 x Ø: 9 cm 0,04 kg

DIMMABLE FUNCTION

Yes. Ensure your dimmer is compatible with LED.

VOLTAGE
220-240V

MAX LOAD
7W

FREQUENCY
50/60 Hz

IP RATING
IP20

CLASSIFICATION
Class II

SOCKET
GX53

LIGHT SOURCE - INCLUDED
LED included: GX53 Art. No.: 502028
Power: 5W±10%
CCT: 3 000K
Output: 400lm ±10%
Life Span: 15000-20000
CRI: ~80

GENERAL STANDARD & CERTIFICATES
EN 55015:2013
EN 55015:2013+A1:2015
EN 61547:2009
EN 61000-3-2:2014
EN 61000-3-3:2013

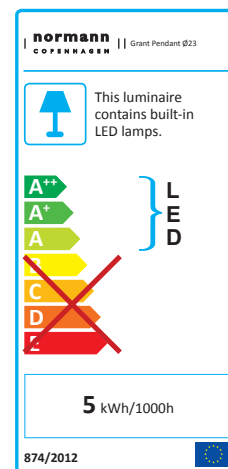

COLOR



Grant Pendant Ø45 cm - EU Version

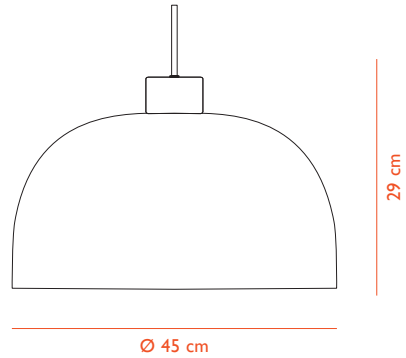

DESCRIPTION

The Grant pendant lamps in two sizes provide ample opportunity for lighting up spaces of various size and character. Due to the dispersion lens, the pendants can be hung high without blinding. An aesthetic and space-optimizing lighting solution, the Grant wall lamps have arms that move from right to left and lampshades that can be tipped up and down, allowing the lamps to take up several different positions.

DESIGN

Simon Legald, 2018

MATERIAL

Brass Plated Steel / Black Plated Steel / Granite

CONSTRUCTION

The six versions of Grant collection are constructed with a replaceable low-energy LED light source with dispersion lens, which is attached with small brass finger screws. The wall lamp versions can move from side to side (ca. 180 degrees). A ball joint connection on the table and floor lamp allows the lampshades to be positioned in diverse directions.

MAINTENANCE

Clean with damp cloth. Avoid use of all-purpose cleaners and other degreasing detergents.

CORD

4 m textile cord, black color.

CANOPY

Included, black color, H: 7,7 x Ø: 9 cm 0,04 kg

DIMMABLE FUNCTION

Yes. Ensure your dimmer is compatible with LED.

VOLTAGE
220-240V

MAX LOAD
7W

FREQUENCY
50/60 Hz

IP RATING
IP20

CLASSIFICATION
Class II

SOCKET
GX53

LIGHT SOURCE - INCLUDED
LED included: GX53 Art. No.: 502029
Power: 7W±10%
CCT: 3 000K
Output: 610lm ±10%
Life Span: 15000-20000
CRI: ~80

GENERAL STANDARD & CERTIFICATES
EN 55015:2013
EN 55015:2013+A1:2015
EN 61547:2009
EN 61000-3-2:2014
EN 61000-3-3:2013

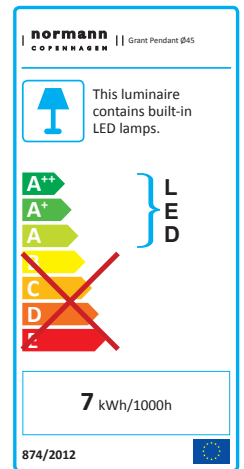

COLOR

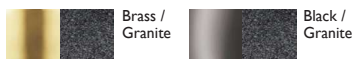

Grant Table Lamp - EU Version

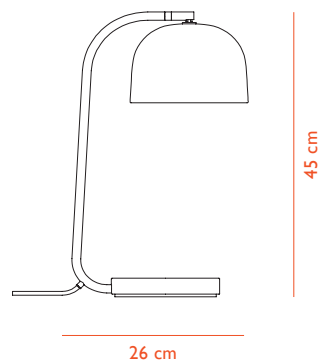

DESCRIPTION

The Grant table lamp is a sophisticated desk lamp for the home office, but equally fit for the bedside table or living room sideboard. Tilt the lampshade up and down to direct the light and scroll on the cord's dimmer switch to go from soft ambience light to a bright reading light.

DESIGN

Simon Legald, 2018

MATERIAL

Brass Plated Steel / Black Plated Steel / Granite

CONSTRUCTION

The six versions of Grant collection are constructed with a replaceable low-energy LED light source with dispersion lens, which is attached with small brass finger screws. The wall lamp versions can move from side to side (ca. 180 degrees). A ball joint connection on the table and floor lamp allows the lampshades to be positioned in diverse directions.

MAINTENANCE

Clean with damp cloth. Avoid use of all-purpose cleaners and other degreasing detergents.

CORD

4 m textile cord with switch, black color.

DIMMABLE FUNCTION

Yes.

VOLTAGE

220-240 V

MAX LOAD

7 W

FREQUENCY

50/60 Hz

IP RATING

IP20

CLASSIFICATION

Class II

SOCKET

GX53

LIGHT SOURCE - INCLUDED

LED included: GX53 Art. No.: 502027

Power: 4W ± 10%

CCT: 3 000 K

Output: 300 lm ± 10%

Life Span: 15 000-20 000

CRI: ~ 80

GENERAL STANDARD & CERTIFICATES

EN 55015:2013

EN 55015:2013+A1:2015

EN 61547:2009

EN 61000-3-2:2014

EN 61000-3-3:2013

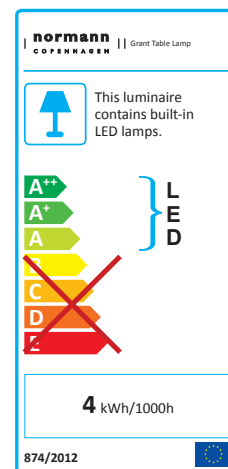

COLOR



Brass /
Granite



Black /
Granite

Grant Floor Lamp - EU Version

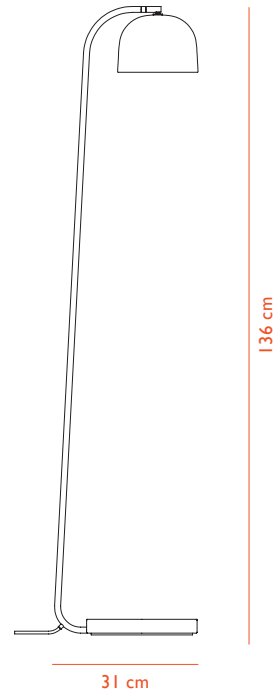

DESCRIPTION

Sharing the same features as the Grant table lamp, an adjustable shade and dimmer switch, the Grant floor lamp is ideal as a reading lamp or for lighting up dark corners.

DESIGN

Simon Legald, 2018

MATERIAL

Brass Plated Steel / Black Plated Steel / Granite

CONSTRUCTION

The six versions of Grant collection are constructed with a replaceable low-energy LED light source with dispersion lens, which is attached with small brass finger screws. The wall lamp versions can move from side to side (ca. 180 degrees). A ball joint connection on the table and floor lamp allows the lampshades to be positioned in diverse directions.

MAINTENANCE

Clean with damp cloth. Avoid use of all-purpose cleaners and other degreasing detergents.

CORD

4 m textile cord with switch, black color.

DIMMABLE FUNCTION

Yes.

VOLTAGE
220-240 V

MAX LOAD
7 W

FREQUENCY
50/60 Hz

IP RATING
IP20

CLASSIFICATION
Class II

SOCKET
GX53

LIGHT SOURCE - INCLUDED

LED included: GX53 Art. No.: 502027
Power: 4W±10%
CCT: 3 000K
Output: 300lm ±10%
Life Span: 15000-20000
CRI: ~80

GENERAL STANDARD & CERTIFICATES

EN 55015:2013
EN 55015:2013+A1:2015
EN 61547:2009
EN 61000-3-2:2014
EN 61000-3-3:2013

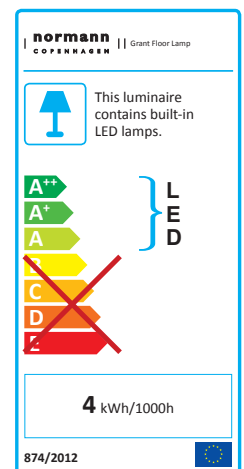

COLOR

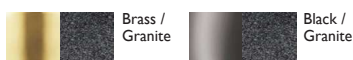

Grant Wall Lamp 43 cm - EU Version

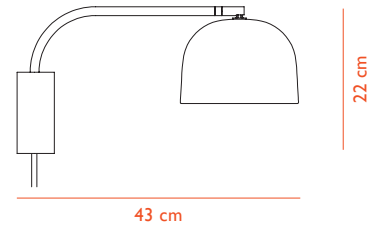

DESCRIPTION

An aesthetic and space-optimizing lighting solution, the Grant wall lamps have arms that move from right to left and lampshades that can be tipped up and down, allowing the lamps to take up several different positions.

DESIGN

Simon Legald, 2018

MATERIAL

Brass Plated Steel / Black Plated Steel / Granite

CONSTRUCTION

The six versions of Grant collection are constructed with a replaceable low-energy LED light source with dispersion lens, which is attached with small brass finger screws. The wall lamp versions can move from side to side (ca. 180 degrees). A ball joint connection on the table and floor lamp allows the lampshades to be positioned in diverse directions.

MAINTENANCE

Clean with damp cloth. Avoid use of all-purpose cleaners and other degreasing detergents.

CORD

4 m textile cord with switch, black color.

DIMMABLE FUNCTION

Yes.

VOLTAGE
220-240 V

MAX LOAD
7 W

FREQUENCY
50/60 Hz

IP RATING
IP20

CLASSIFICATION
Class II

SOCKET
GX53

LIGHT SOURCE - INCLUDED

LED included: GX53 Art. No.: 502027
Power: 4W±10%
CCT: 3 000K
Output: 300lm ±10%
Life Span: 15000-20000
CRI: ~80

GENERAL STANDARD & CERTIFICATES

EN 55015:2013
EN 55015:2013+A1:2015
EN 61547:2009
EN 61000-3-2:2014
EN 61000-3-3:2013

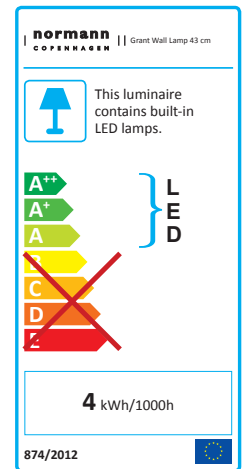

COLOR

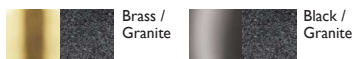

Grant Wall Lamp 111 cm - EU Version

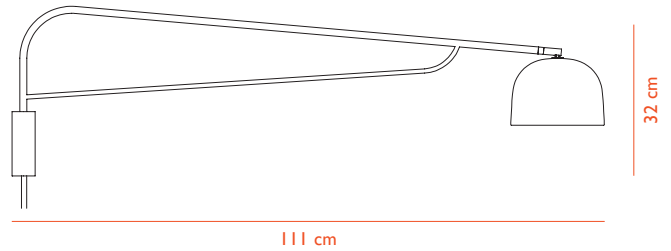

DESCRIPTION

An aesthetic and space-optimizing lighting solution, the Grant wall lamps have arms that move from right to left and lampshades that can be tipped up and down, allowing the lamps to take up several different positions.

DESIGN

Simon Legald, 2018

MATERIAL

Brass Plated Steel / Black Plated Steel / Granite

CONSTRUCTION

The six versions of Grant collection are constructed with a replaceable low-energy LED light source with dispersion lens, which is attached with small brass finger screws. The wall lamp versions can move from side to side (ca. 180 degrees). A ball joint connection on the table and floor lamp allows the lampshades to be positioned in diverse directions.

MAINTENANCE

Clean with damp cloth. Avoid use of all-purpose cleaners and other degreasing detergents.

CORD

4 m textile cord with switch, black color.

DIMMABLE FUNCTION

Yes.

VOLTAGE
220-240 V

MAX LOAD
7 W

FREQUENCY
50/60 Hz

IP RATING
IP20

CLASSIFICATION
Class II

SOCKET
GX53

LIGHT SOURCE - INCLUDED

LED included: GX53 Art. No.: 502027
Power: 4W±10%
CCT: 3 000K
Output: 300lm ±10%
Life Span: 15000-20000
CRI: ~80

GENERAL STANDARD & CERTIFICATES

EN 55015:2013
EN 55015:2013+A1:2015
EN 61547:2009
EN 61000-3-2:2014
EN 61000-3-3:2013

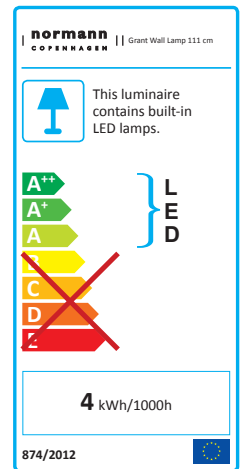

COLOR

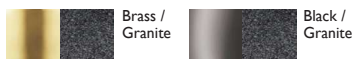

GRANT

US Version



normann
COPENHAGEN

Grant Pendant Ø23 cm - US Version

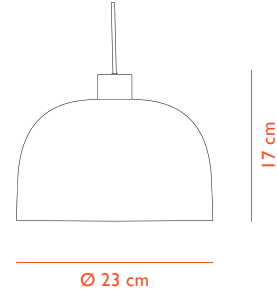

DESCRIPTION

The Grant pendant lamps in two sizes provide ample opportunity for lighting up spaces of various size and character. Due to the dispersion lens, the pendants can be hung high without blinding. An aesthetic and space-optimizing lighting solution, the Grant wall lamps have arms that move from right to left and lampshades that can be tipped up and down, allowing the lamps to take up several different positions.

DESIGN

Simon Legald, 2018

MATERIAL

Brass Plated Steel / Black Plated Steel / Granite

CONSTRUCTION

The six versions of Grant collection are constructed with a replaceable low-energy LED light source with dispersion lens, which is attached with small brass finger screws. The wall lamp versions can move from side to side (ca. 180 degrees). A ball joint connection on the table and floor lamp allows the lampshades to be positioned in diverse directions.

MAINTENANCE

Clean with damp cloth. Avoid use of all-purpose cleaners and other degreasing detergents.

CORD

4 m textile cord, black color.

CANOPY

Included, black color, H: 7,7 x Ø: 9 cm 0,04 kg

DIMMABLE FUNCTION

Yes - Ensure your dimmer is compatible with LED.

VOLTAGE

120V

MAX LOAD

7W

FREQUENCY

60 Hz

IP RATING

IP20

CLASSIFICATION

Class I

SOCKET

GX53

LIGHT SOURCE - INCLUDED

LED included: GX53 Art. No.: 502028

Power: 5W ± 10%

CCT: 3 000 K

Output: 400 lm ± 10%

Life Span: 15 000-20 000

CRI: ~ 80

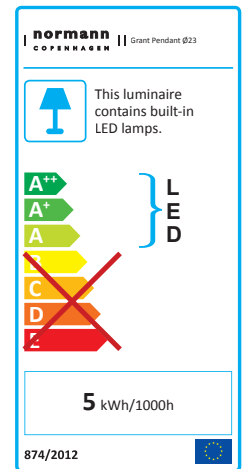

COLOR

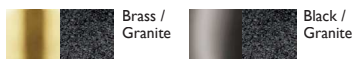

Grant Pendant Ø45 cm - US Version

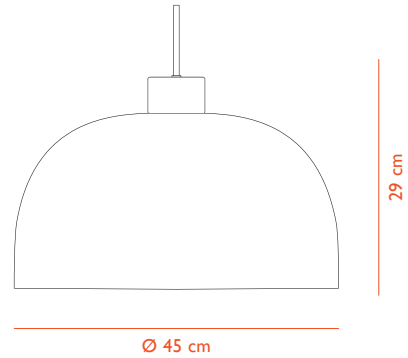

DESCRIPTION

The Grant pendant lamps in two sizes provide ample opportunity for lighting up spaces of various size and character. Due to the dispersion lens, the pendants can be hung high without blinding. An aesthetic and space-optimizing lighting solution, the Grant wall lamps have arms that move from right to left and lampshades that can be tipped up and down, allowing the lamps to take up several different positions.

DESIGN

Simon Legald, 2018

MATERIAL

Brass Plated Steel / Black Plated Steel / Granite

CONSTRUCTION

The six versions of Grant collection are constructed with a replaceable low-energy LED light source with dispersion lens, which is attached with small brass finger screws. The wall lamp versions can move from side to side (ca. 180 degrees). A ball joint connection on the table and floor lamp allows the lampshades to be positioned in diverse directions.

MAINTENANCE

Clean with damp cloth. Avoid use of all-purpose cleaners and other degreasing detergents.

CORD

4 m textile cord, black color.

CANOPY

Included, black color, H: 7,7 x Ø: 9 cm 0,04 kg

DIMMABLE FUNCTION

Yes - Ensure your dimmer is compatible with LED.

VOLTAGE

120V

MAX LOAD

7W

FREQUENCY

60 Hz

IP RATING

IP20

CLASSIFICATION

Class I

SOCKET

GX53

LIGHT SOURCE - INCLUDED

LED included: GX53 Art. No.: 502029

Power: 7W±10%

CCT: 3 000K

Output: 610lm ±10%

Life Span: 15 000-20 000

CRI: ~80

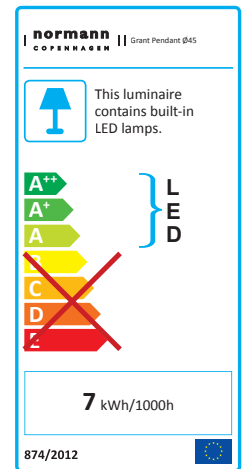

COLOR

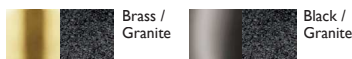

Grant Table Lamp - US Version

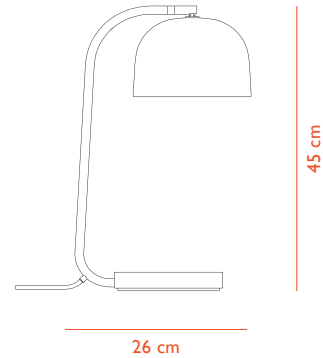

DESCRIPTION

The Grant table lamp is a sophisticated desk lamp for the home office, but equally fit for the bedside table or living room sideboard. Tilt the lampshade up and down to direct the light and scroll on the cord's dimmer switch to go from soft ambience light to a bright reading light.

DESIGN

Simon Legald, 2018

MATERIAL

Brass Plated Steel / Black Plated Steel / Granite

CONSTRUCTION

The six versions of Grant collection are constructed with a replaceable low-energy LED light source with dispersion lens, which is attached with small brass finger screws. The wall lamp versions can move from side to side (ca. 180 degrees). A ball joint connection on the table and floor lamp allows the lampshades to be positioned in diverse directions.

MAINTENANCE

Clean with damp cloth. Avoid use of all-purpose cleaners and other degreasing detergents.

CORD

4 m textile cord with switch, black color.

DIMMABLE FUNCTION

Yes.

VOLTAGE

120V

MAX LOAD

7W

FREQUENCY

60 Hz

IP RATING

IP20

CLASSIFICATION

Class I

SOCKET

GX53

LIGHT SOURCE - INCLUDED

LED included: GX53 Art. No.: 502027

Power: 4W ± 10%

CCT: 3 000K

Output: 300 lm ± 10%

Life Span: 15 000-20 000

CRI: ~ 80

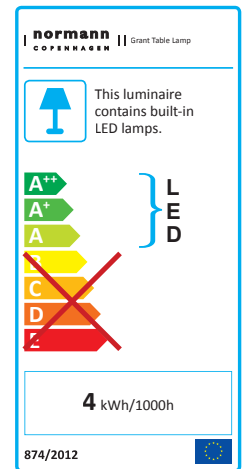

COLOR



Grant Floor Lamp - US Version

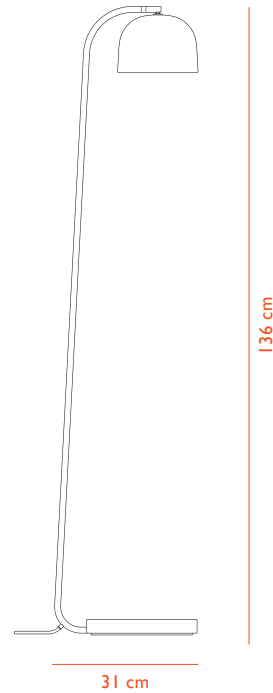

DESCRIPTION

Sharing the same features as the Grant table lamp, an adjustable shade and dimmer switch, the Grant floor lamp is ideal as a reading lamp or for lighting up dark corners.

DESIGN

Simon Legald, 2018

MATERIAL

Brass Plated Steel / Black Plated Steel / Granite

CONSTRUCTION

The six versions of Grant collection are constructed with a replaceable low-energy LED light source with dispersion lens, which is attached with small brass finger screws. The wall lamp versions can move from side to side (ca. 180 degrees). A ball joint connection on the table and floor lamp allows the lampshades to be positioned in diverse directions.

MAINTENANCE

Clean with damp cloth. Avoid use of all-purpose cleaners and other degreasing detergents.

CORD

4 m textile cord with switch, black color.

DIMMABLE FUNCTION

Yes.

VOLTAGE

120V

MAX LOAD

7W

FREQUENCY

60 Hz

IP RATING

IP20

CLASSIFICATION

Class I

SOCKET

GX53

LIGHT SOURCE - INCLUDED

LED included: GX53 Art. No.: 502027

Power: 4W±10%

CCT: 3 000K

Output: 300lm ±10%

Life Span: 15 000-20 000

CRI: ~80

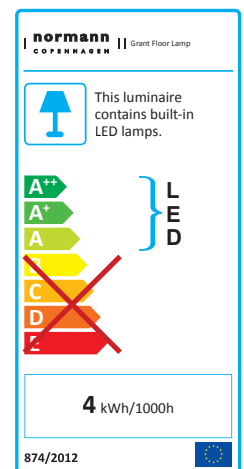

COLOR

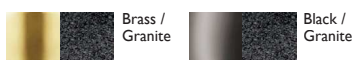

Grant Wall Lamp 43 cm - US Version

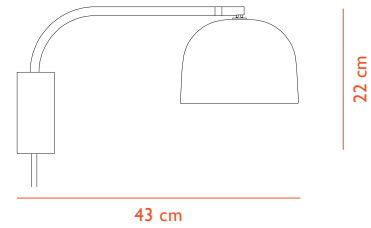

DESCRIPTION

An aesthetic and space-optimizing lighting solution, the Grant wall lamps have arms that move from right to left and lampshades that can be tipped up and down, allowing the lamps to take up several different positions.

DESIGN

Simon Legald, 2018

MATERIAL

Brass Plated Steel / Black Plated Steel / Granite

CONSTRUCTION

The six versions of Grant collection are constructed with a replaceable low-energy LED light source with dispersion lens, which is attached with small brass finger screws. The wall lamp versions can move from side to side (ca. 180 degrees). A ball joint connection on the table and floor lamp allows the lampshades to be positioned in diverse directions.

MAINTENANCE

Clean with damp cloth. Avoid use of all-purpose cleaners and other degreasing detergents.

CORD

4 m textile cord with switch, black color.

DIMMABLE FUNCTION

Yes.

VOLTAGE

120V

MAX LOAD

7W

FREQUENCY

60 Hz

IP RATING

IP20

CLASSIFICATION

Class I

SOCKET

GX53

LIGHT SOURCE - INCLUDED

LED included: GX53 Art. No.: 502027

Power: 4W±10%

CCT: 3 000K

Output: 300lm ±10%

Life Span: 15000-20000

CRI: ~80

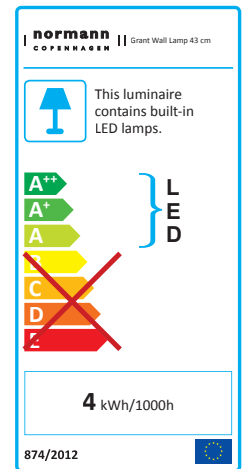

COLOR

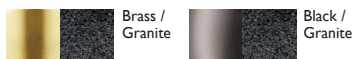

Grant Wall Lamp 111 cm - US Version

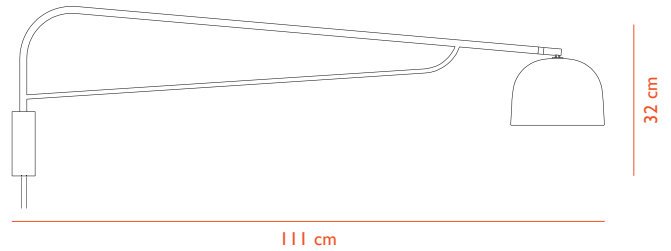

DESCRIPTION

An aesthetic and space-optimizing lighting solution, the Grant wall lamps have arms that move from right to left and lampshades that can be tipped up and down, allowing the lamps to take up several different positions.

DESIGN

Simon Legald, 2018

MATERIAL

Brass Plated Steel / Black Plated Steel / Granite

CONSTRUCTION

The six versions of Grant collection are constructed with a replaceable low-energy LED light source with dispersion lens, which is attached with small brass finger screws. The wall lamp versions can move from side to side (ca. 180 degrees). A ball joint connection on the table and floor lamp allows the lampshades to be positioned in diverse directions.

MAINTENANCE

Clean with damp cloth. Avoid use of all-purpose cleaners and other degreasing detergents.

CORD

4 m textile cord with switch, black color.

DIMMABLE FUNCTION

Yes.

VOLTAGE

120V

MAX LOAD

7W

FREQUENCY

60 Hz

IP RATING

IP20

CLASSIFICATION

Class I

SOCKET

GX53

LIGHT SOURCE - INCLUDED

LED included: GX53 Art. No.: 502027

Power: 4W±10%

CCT: 3 000K

Output: 300lm ±10%

Life Span: 15000-20000

CRI: ~80

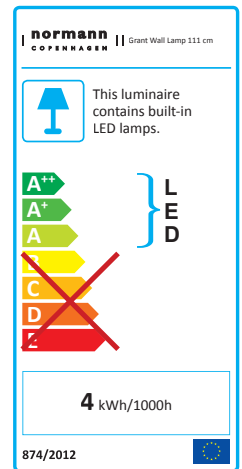

COLOR

